

## Assembling and welding the turbine kit

Begin by locating the stator backing plate and bearing hub as shown in the picture below...



Next.. Insert the bearing hub in the stator plate center hole. You may need to take some sandpaper to clean up the hole to get the hub to slip in. It's a snug fit. Make sure the bearing hub is flush with the face of the plate before welding. You don't need to weld all the way around the hub as this is not a structural area, it only holds the stator in place. Four welds equally spaced about  $\frac{1}{2}$  to  $\frac{3}{4}$  inch long is more than sufficient. Be careful not to burn through into the bearing surface. The picture below shows how it should look when it's completed...



**Below is a picture of the welded assembly from the back side of the unit. The welds are placed in line with the stator mounting holes**



**Once this is completed you can weld the yaw tube bracket in place. This is welded between a pair of mounting holes on the stator mounting plate so there is easy access to the holes as shown in the picture below...**



**Notice that the end of the yaw bracket hangs over the end of the bearing hub about  $\frac{1}{4}$  of an inch. Once positioned weld the top and bottom of the yaw bracket to the bearing hub. Be careful not to burn into the bearing surface, especially on the ends or you'll be grinding the edges to fit the bearing.**

**Next find the yaw tube and insert it into the yaw bracket hole. Center the tube in the bracket (about 4 inches on top and bottom). The hole is sloppy so we can add a bit of tilt to the turbine. Lift the**

bottom side of the tube then tack weld it in place. This will add about a 2-degree tilt to help keep the bottom of the blade away from the tower. The picture below shows the tube welded in place...



Next you will weld the angle bracket on the yaw tube. You can weld the bracket to the tail angle mount first or the other way around, it doesn't really matter. What does matter is the positioning of the bracket or assembly before welding. Below shows a diagram... it should be welded 45 degrees off.

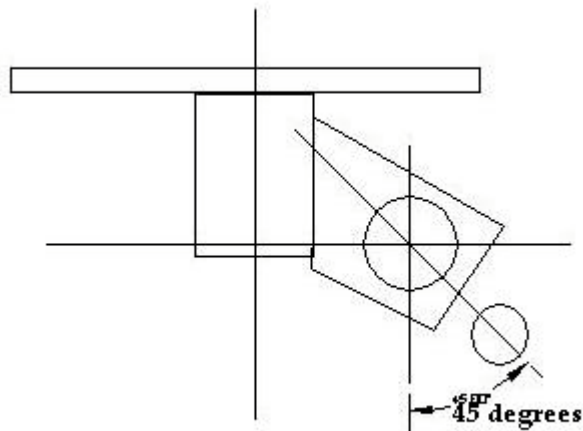

**The final piece to weld in place is the yaw tube stop washer. Simply weld this to the top of the yaw tube. Center it and weld in 3 - 1-inch long welds in 3 places around the tube... As shown in the following picture.**



**Once all is welded let the assembly cool down. Then take a wire brush and clean the welds and remove any splatter that may have occurred. After its cooled it can be painted the color of your choice and the bearings can be installed. When the bearings are installed make sure you tap them in until they are seated against the inner-protruding surface. If they are not then things could go wrong when the turbine is in the air flying. The bearings could move around changing the gap of the stator or even driving the magnet discs into the stator. So seating them is important!**

**Next step is assembling the rotor and installing the shaft....**

**Find the shaft, 1/4" aluminum spacer, magnet plate spacer and one of the 8 inch discs... as in the picture below...**



**Slide the shaft in the bearing hub and install the locking collar on the back of the turbine head and lock it in place. You should have  $\frac{1}{4}$  to  $\frac{1}{2}$  inch of shaft extending beyond the locking collar.. as shown in the picture below...**



**Now slide the aluminum spacer down the shaft on the front of the turbine as shown below...**

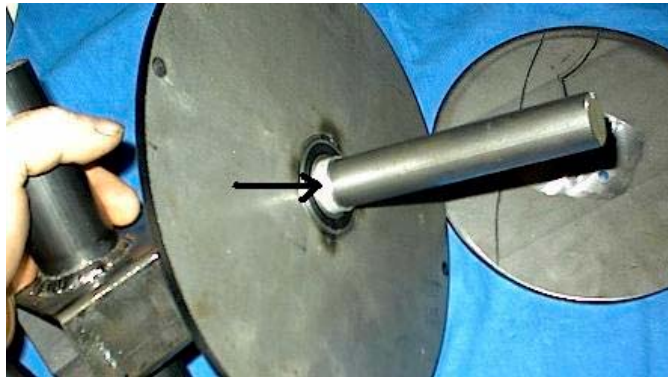

**Slide one of the 8-inch discs over the shaft down to the aluminum spacer... as shown below...**



**Install the aluminum magnet disc spacer with the ¼ inch key on the shaft against the disc. Don't worry about bolting them together at this point because were simply going to dis-assemble the shaft in the next step. Tighten the set screw so the magnet disc spacer is locked in place. Now you can remove the locking collar on the backside and slide the assembly out of the bearing hub. Now we'll work on the magnet layout...**

**There are 12 magnets on each disc, they will have to be positioned every 30 degrees in an opposing layout. So one magnet will go down with its North facing up and the next one will have its South facing up. No need to get all uptight about which is which on the magnet you simply lay down the first one then the next one down must repel the first and all others will repel the one preceding it.**

**You can lay it out with a protractor or print this sheet out, cut out the layout and mark it on the plate. I use a permanent marker with a fairly fine point for this. Its best to start by drawing a line through the center of two of the mounting bolt holes and mark the top with a star or dot or anything that will identify the top of that plate.**

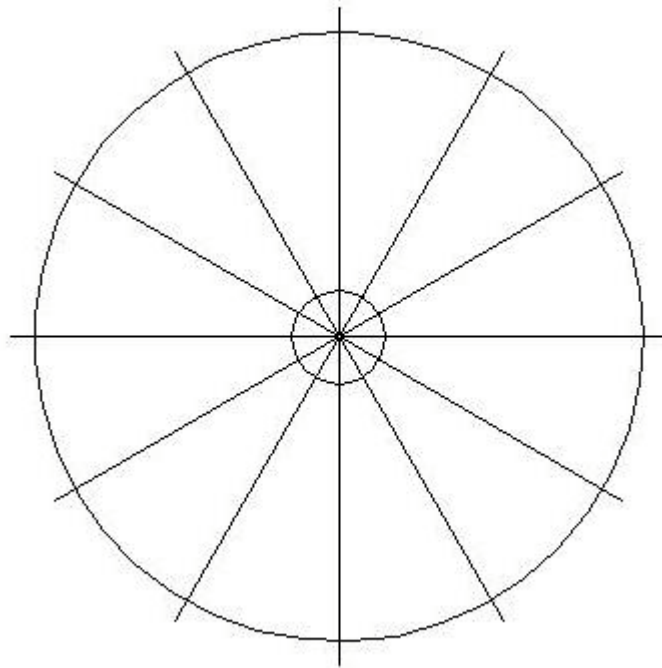

**Line up the template so the centerlines go through the centers of the 4-bolt pattern on the disc and tape it in place. Use a ruler to extend the lines onto the disc. You can hold the disc up to a light so it shines through the holes to help line things up. Shown below is the disc with a template taped to it...**



Then mark the lines on the disc as shown below

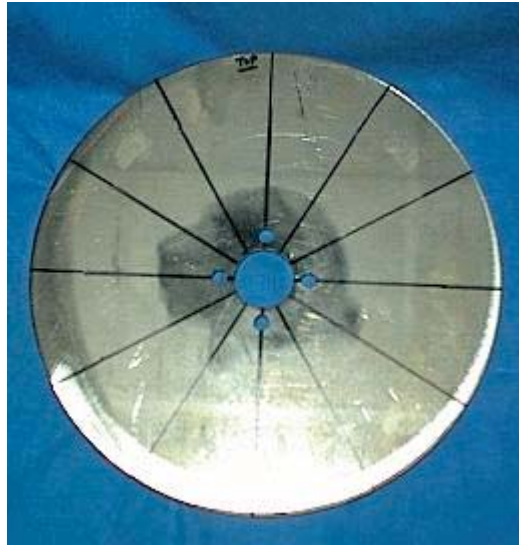

Now the tricky part... You want to make sure the magnets line up before you start gluing them in place. Bring the discs up face to face (markings are pointed at each other). As shown below...

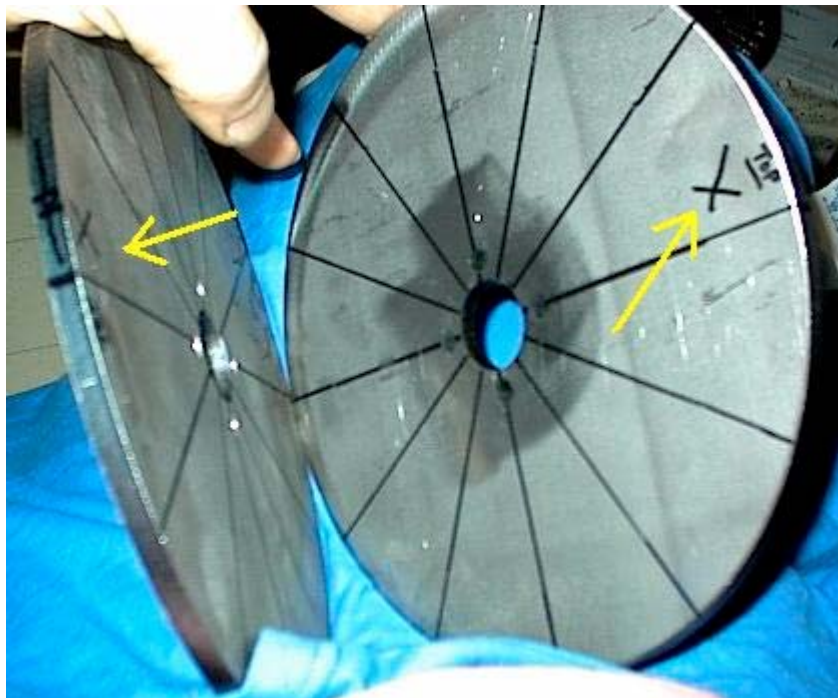

Note that the matching magnets will be mounted on one side of the line on one disc and just the opposite on the other disc. You want to make sure your starting point is where you marked the disc as the top and the bolt holes line up properly. This way when the assembly is complete everything will line up when bolted together. I placed an "X" on the side of the line where the magnet is to be placed.

Now we begin gluing magnets on the discs. **First take note that extreme care must be taken when working with the neodymium magnets.** They like to attract metal things in the surrounding area so

set up a work area where they can be worked with one at a time without any magnetic objects close by.

We'll start by gluing the first magnet to one disc in the appropriate area. It doesn't matter North or south simply glue it in place. I use JB quick weld, sparingly I should add, to glue them in place.

Only mix enough to do 2 or 3 magnets or you'll go through a bunch of the stuff. I use only a small amount under each magnet otherwise it will be difficult to keep the magnets from wondering around until it sets, as well, it will make quite the mess. Also, you want the magnet to stay as close to the disc as possible, too much may have a tendency to hold the magnet up from the disc and not squeeze out giving you a non uniform layer.

Ok so mix up enough JB for one magnet on each disc. The first magnet on the second disc should attract to the first magnet on the first disc. **(Do not put them on the disc and bring the discs together to check for attraction – take one in your hand for the second disc to check for attraction. The attraction side will face the magnet that it is attracted to and the glued surface is pointed away from the magnet on the first disc.)**

Shown below... first magnet on first disc...

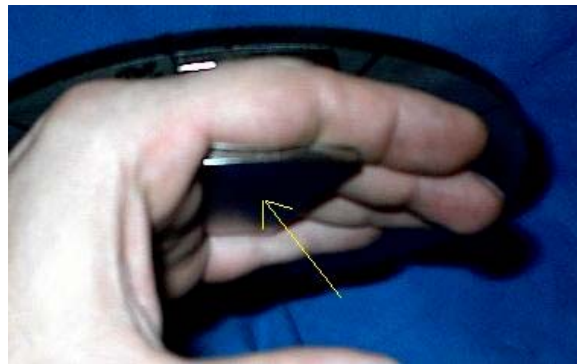

Checking for attraction on the second magnet for the second disc... Carefully!

The yellow arrow shows the surface that will be glued to the second disc in the photo above



Below shows the two discs with their respective magnets in place...

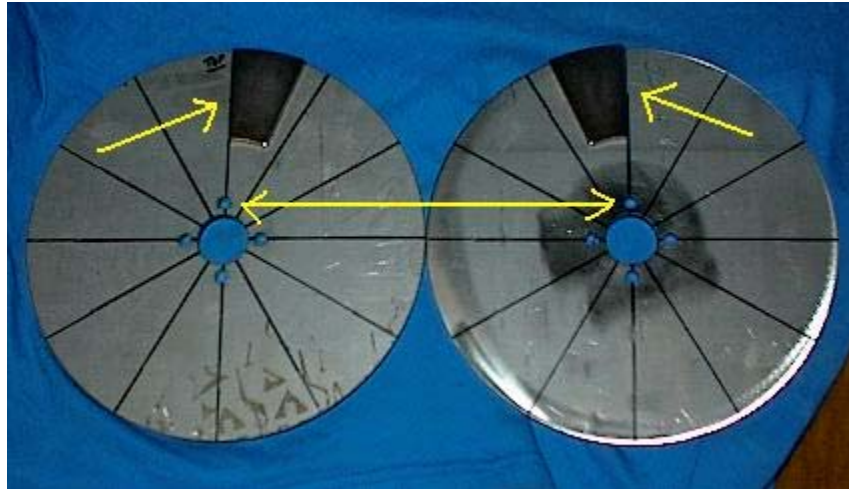

Note the magnets are placed on the opposite sides of the lines you drew and are lined up with the respective mounting hole. When they are face to face the magnets will line up with each other with a very very strong attractive force I might add.

You can double check that you have them properly pole oriented by taking a magnet, at a distance, and check them. One should attract and with the same face the other should repel. Also, to make absolutely sure you have them properly oriented you can take a 2x4 and place the board over one magnet and bring the discs together, if it attracts its fine. If not, it repels then you'll need to flip one over. Its good to make absolutely sure before you get them all glued in place and/or after you've poured the plastic.

Once you have one magnet on each disc then the others can be put into place to finish the magnet installation. Take the disc your not going to work on right away and get it out of the way to assure nothing will be attracted to it while you work on the other.

You can work in either direction as long as you place the magnet on the same side of the line as the first one. Every magnet that goes on the plate will repel the one preceding it. If it repels that is the face that will go down on the plate. Again only mix enough JB to do a couple magnets at a time and don't be in a hurry you may need to keep an eye on the ones previously to make sure their not creeping around on you.

When one is done you can check the polarity of the magnets by taking one and going around the disc, one should attract the other should repel in that order all the way around. If you have two in a row that are attracting or repelling then you'll have to change the one that is incorrect. Once all the magnets are on the disc **put it somewhere safe** then proceed with the second disc following the same procedure as the first.

**NOTE: Under no circumstances should these discs be placed in close proximity of each other except on final assembly. If these discs snap together (magnet to magnet) there is NO way to get them apart with out destroying the magnets and/or discs (not to mention if a body part is between them). When these magnets are placed on the steel disc with opposing poles it creates a magnetic pull of massive force. One disc stuck to the roof of a small compact car will lift it without releasing.**

**BE AWARE OF WHAT YOU ARE DOING AT ALL TIMES WHEN HANDLING THESE DISCS!**

Now that I've put the fear of the discs into you we can move on to pouring plastic around themagnets and finalizing the magnetic plates... Below are pictures of the process of gluing the magnets in place as well as the discs as they progress ....

Below is a picture showing the JB, remember you don't need a big glob, If you use a lot you'll have to hold the magnets in place while it dries and they will want to wonder around. Just a quick wipe of glue will be sufficient.

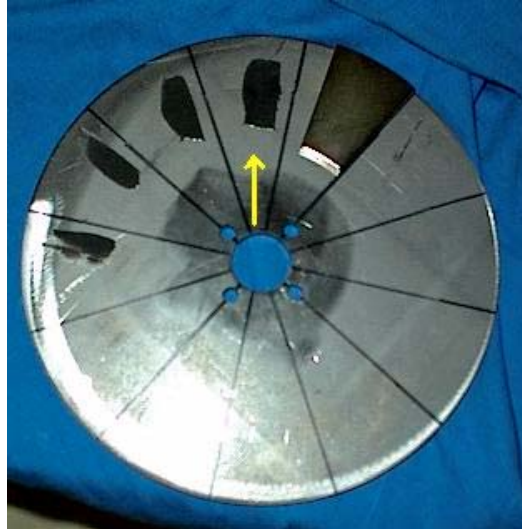

Below shows the magnets glued and ready for the final preparation, note I put an X on the magnets that signifies the top or how the plates will line up with the bolt holes. Once the plastic is poured it's hard to tell which way they went...

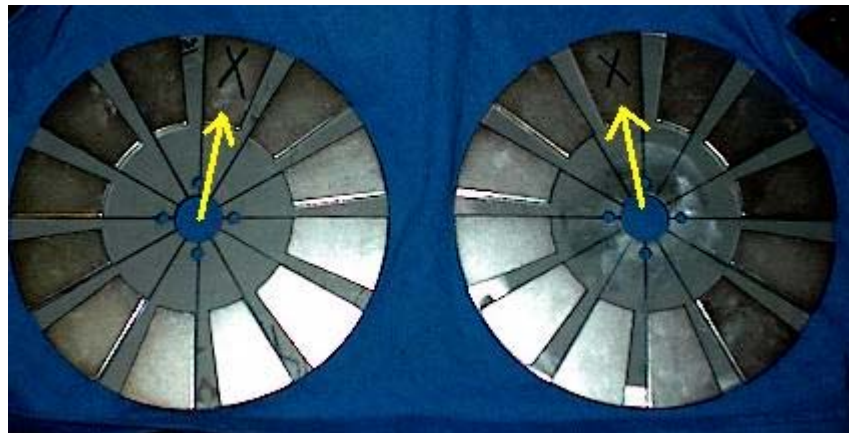

Now, tape the edge all the way around the circumference of the disc to form a lip that will keep the plastic from running all over the floor. Also find a round piece approximately 2 ¼ to 2 ½ inches in diameter for the center. As shown below...

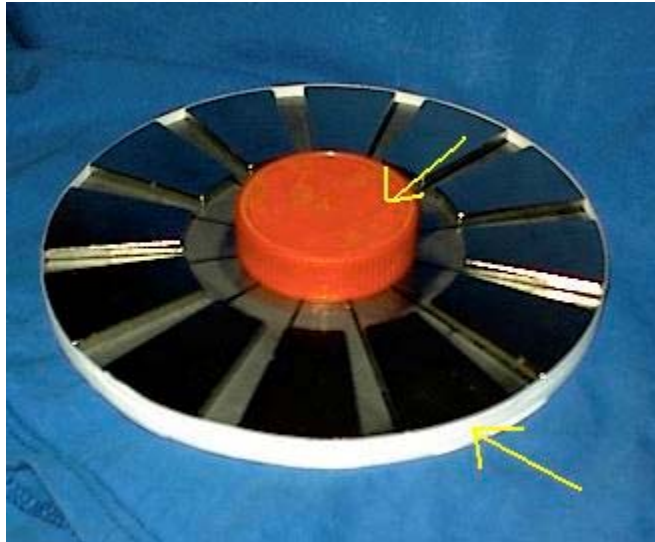

I used some white bandage tape to go around the disc and found a plastic top from a jar that just happened to be 2 ½ inches. You will want to use some grease or car wax around the plastic top where the plastic will fill otherwise the cap becomes a permanent member of the disc. Also, you'll want to find some objects with weight to hold the cap in place while pouring the plastic otherwise it will move around on you.

I used a simple 1 to 1 mix of smooth cast 300 for doing this, it isn't necessary that you use the same thing. A fiberglass resin works just as well and is easy to find at the local hardware or automotive store. The smooth cast is from [www.smoothon.com](http://www.smoothon.com) if you wish to look into it. Its actually quite nice stuff with an easy 1 to 1 mix and it pours like water (almost). It has a very short pot life of around 2 to 3 minutes and is ready to take out of the mold in about 15 minutes so if you mix it you better be ready to use it. Fiber glass resin has a long pot life and usually takes overnight to fully cure so you have plenty of time to work with it.

You can set your discs aside ( in a safe place ) and we'll start working on the Stator... You can paint the parts as you go or paint them all at once before final assembly.

## Building the Stator mold and Alternator

We'll start by building the mold for the stator then get into the nitty gritty of the coils and wiring...

You'll need enough  $\frac{3}{4}$  inch plywood to cut out 2 – 14 inch x 14 inch squares for the base of the mold and lid. The next piece will be  $\frac{1}{2}$  inch plywood cut also into a 14 inch x 14 inch square. The  $\frac{1}{2}$  inch plywood should be of reasonably good grade, sanded both sides and the  $\frac{3}{4}$ " only needs to be sanded one side. I used some rough CDX exterior plywood that wasn't too bad on one side and sanded it myself. The faces have to have a fairly smooth surface to make sure the poured plastic doesn't stick.

Below shows the layout of the stator mold base. Find the center by going corner to corner and draw the lines. I also marked the  $2\frac{1}{2}$  inch center for the center riser, the 4 inch inside diameter of the magnets, the 8 inch outside diameter of the magnets and lastly the 11 inch diameter of the stator mold to help center things up. The center gets a  $\frac{1}{4}$  inch hole to line things up in the beginning.



By drawing in the 8" and 4" diameters gives you a reference of where the magnets will be running. Later when you lay in the coils you can make sure there in the right place.

Next, the below picture shows the lid laid out. It's a little hard to see the lines in the picture but the center was marked the same as the base board was and the center is drilled with a  $\frac{1}{4}$  inch drill. The 11 inch circle was drawn then the outer circle is drawn at 12.5 inches. You'll add 2 more lines to the center lines to make an 8 bolt pattern on the lid.

Take the  $\frac{1}{2}$  inch plywood, find center and cut an 11 inch diameter from the center. Use a piece of the



cutout to make a  $2\frac{1}{2}$  inch diameter piece for the center riser and when your done it should look something like this...



**You can drill the center hole of the center riser to match the  $\frac{1}{4}$  inch hole in the other boards. I used fiberglass resin on the lid surface and base surface to make sure they were smooth. Also, the resin was sanded to make it as smooth as possible. You could use a varnish or any paint you have laying around as long as it can be sanded smooth. The center board should be coated as well on both sides.**

**When these are done install a  $\frac{1}{4}$  inch bolt through the center of the bottom board and put the center riser in place sliding it down the bolt. Line up the outer stator with the 11 inch circle drawn on the base. Carefully slide the lid down the bolt making sure the center mold doesn't move. Clamp the assembly together and drill through all 8 holes you drilled in the lid. Try to keep them as straight as possible so the bolts won't go in on an angle. I used a drill that was slightly larger than the  $\frac{1}{4}$  in which will help in getting the lid on when you've poured the plastic.**

**Below shows all three parts clamped together ready for drilling...**



**Once all the holes are drilled you should mark one of the edges of all 3 boards so you know which way they go together or simply cut one of the corners off of all 3 boards. I marked them with a permanent marker... quick and simple.**

After its been marked for assembly reference you can disassemble it. Drop a few 1/4 inch bolts through the holes of the center mold to maintain its alignment. Next you'll need some 1 inch drywall screws. Drill and countersink in between each of the 1/4" holes you drilled before. Drill the holes just smaller than the screws. If you don't have a counter sink drill you can use a larger drill bit to open the hole at the top to make sure the screws will be below the surface.

These screws will hold the stator mold in place when pouring to make sure the plastic doesn't seep between the two. After pouring the lid will go on and will be secured by the 8 - 1/4" bolts while it cures.



Below shows the stator mold with screws installed, also notice that two screws are placed in the center riser as well.. otherwise it will "float" when the plastic is poured.

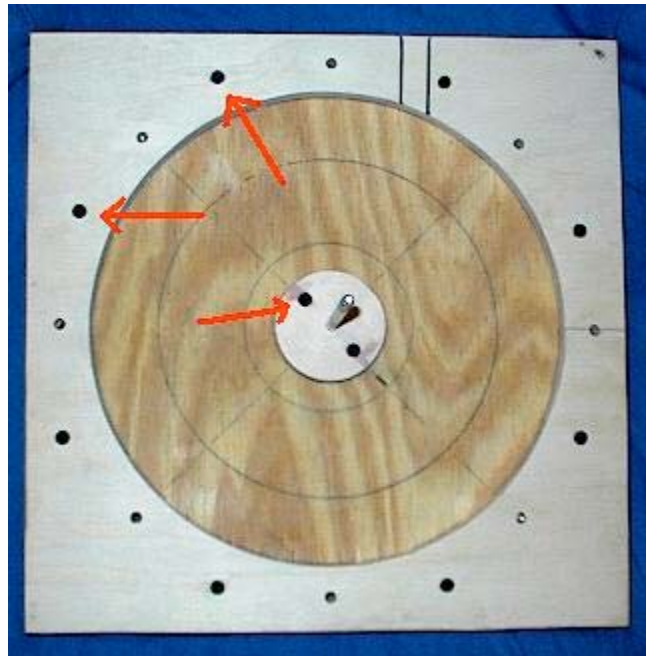

To finish off the stator mold there is one more thing that has to be done before we move on to the coil winding. A slot needs to be put in the lid for the wires to protrude as well as allowing the excess plastic to be squeezed out when the lid is installed and tightened.

The slot needs to be about  $\frac{3}{4}$  inch wide and the hole to start the slot should be drilled just below the 11 inch line. You'll want to sand this slot smooth as well. The picture below shows the slot in the lid..



The slot should be offset slightly from two of the lid mounting holes. Once the slot is completed place the lid on in its appropriate alignment, drop a few bolts in the holes to make sure its aligned and mark the slot on the center stator mold as shown in the above picture where the screws were installed. This will aid in the final wiring process.

Put the mold together and set it aside with all the parts. Next step is winding coils for your stator.

## Coil winding machine and winding coils

Before we can wind the coils we need to build a coil winding machine. Find some scrap  $\frac{3}{4}$  inch plywood and cut 2 pieces  $2\frac{1}{2}$ " x 6", 2 pieces  $2\frac{1}{2}$ " x 4". Bore a  $\frac{5}{16}$  inch hole toward the top of the two  $2\frac{1}{2}$  x 6 in pieces this will be where the  $\frac{5}{16}$  in threaded rod will pass through. Assemble the structure as shown below using  $1\frac{1}{4}$ " drywall screws...

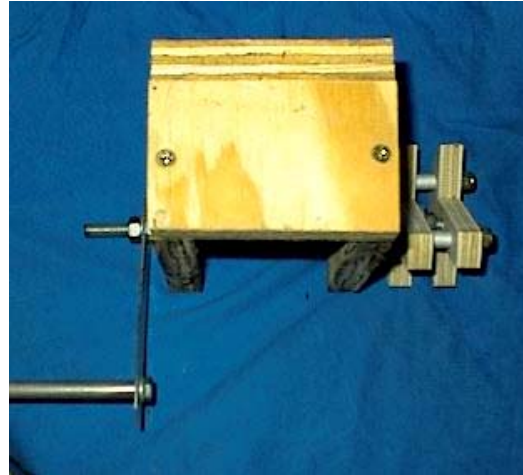

I used some sheet aluminum scrap to make the handle but it can be made of wood or anything handy.

The handle itself can be a dowel held to the arm with a screw, bolt or whatever you can find. No rocket science here, just a simple device to wind the wire. It does need to be sturdy though to wind the coils tightly.

Find the  $\frac{1}{2}$ " plywood piece you cut from the center of the center stator mold ( the 11" diameter) and we will use this scrap to make the coil former. Follow the following drawing to lay out the two discs that will be cut and shaped in the end...

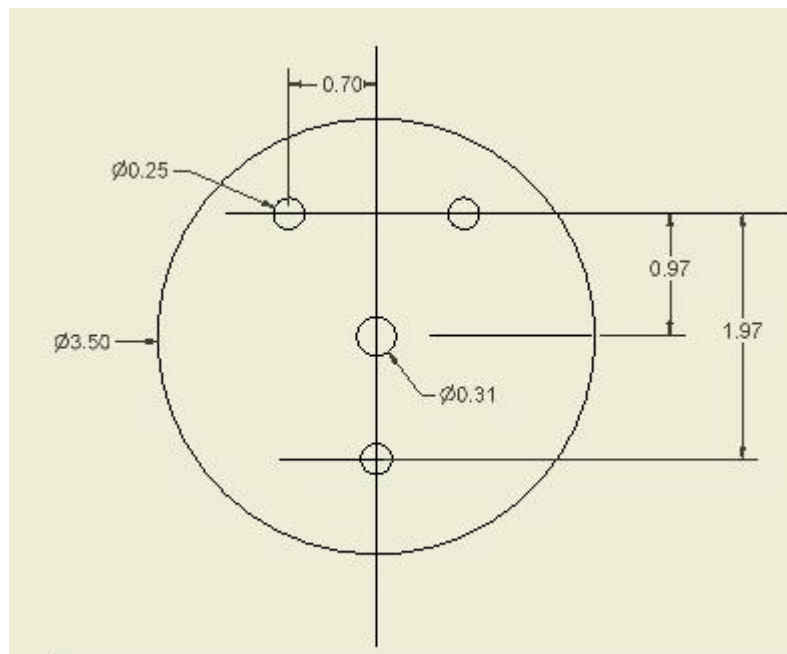



There will be **2 x 3 1/2" in diameter discs laid out as above**. The dimensions that are .97 and 1.97 can be 1" and 2" respectively but the width of the top two holes should be as close to .7 as possible. I usually drill the center 5/16" hole first and put a bolt through them to hold the center then drill one 1/4" hole and put a 1/4" bolt through it to maintain alignment then simply drill through the other two holes. Below shows the 2 discs cut out and drilled...

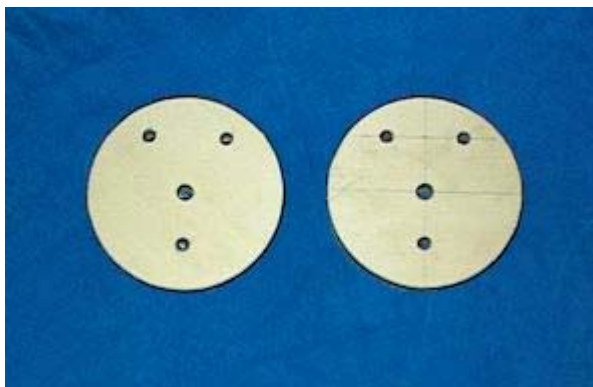

Now shape them to look like a "T". You can cut the top about 3/8" below the holes and the tail is 3/4" wide as shown below...

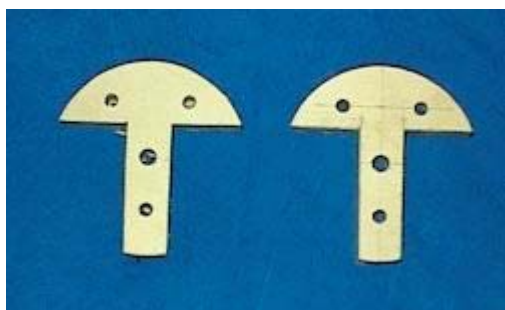

The only critical part is the hole location to make the triangular coils so they fit in place when their completed. The first piece will be tightened against the winding shaft, a washer on each side of the wood former and a nut to hold it in place. This has to be very tight so it doesn't slip while winding. See the picture below...

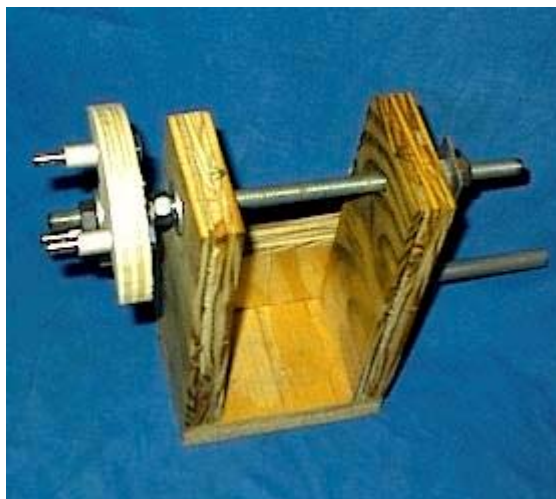

Next you'll need to find some tubing about 3/8" in diameter that a 1/4" bolt will pass through the center. They can be aluminum, copper, steel fuel line as long as their 3/8" in diameter. These need to be cut 1/2 inch long. These will be used as spacers between the wood formers and will make it much easier to remove the coil later. I used some aluminum tubing that I had and cut it with a tube cutter shown below..



The outer former wood will be removed and reinstalled as you wind and complete coils. To make it a little easier to do so you should either hone the holes out with sandpaper or take a drill slightly larger than the holes were drilled including the center hole.

The coil winder is complete and should look something like the below picture...

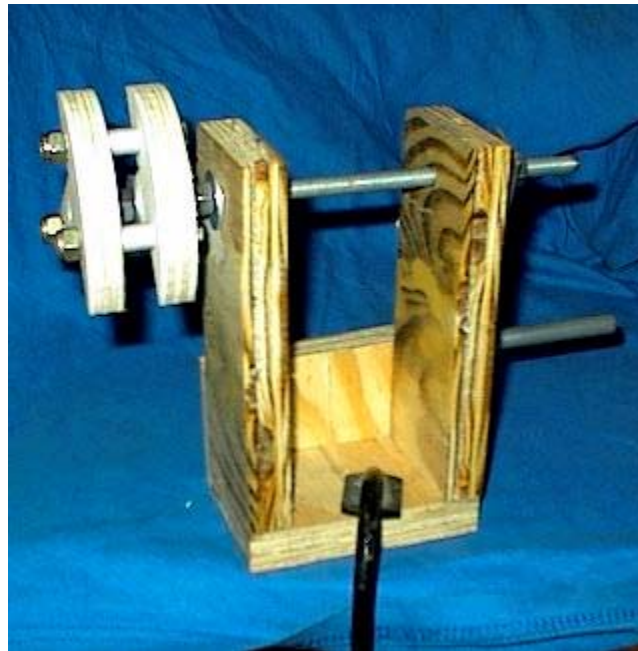

You should clamp the winder to a table edge to hold it steady while winding the coils. There will be a fairly good tension to keep the coils as tight as possible.

## Winding the coils

For the 500 watt 12 volt machine you'll be using #14 wire ( you'll need about 4 lbs of it ). You can use 40, 42, or 44 turns per coil. 44 turns will give you better low wind performance where the 40 turn coils will give better mid and higher wind performance. 40 turns will get a cut in speed in around 7 mph of wind or slightly higher where the 44 turn coil will cut in at around 6mph. Not a big difference except in the higher winds. This unit will make 500 watts in around a 25 – 27 mph winds – about 38 amps at 13 volts.

The stator is a basic 9 coil single layer arrangement, one of the simplest ones to do and it is 3 phase wired in star. The wiring will be covered later. Let's wind some coils...

Starting the coils I take the wire and give it a 90 degree bend leaving about 6 inches of wire hanging out as shown below..

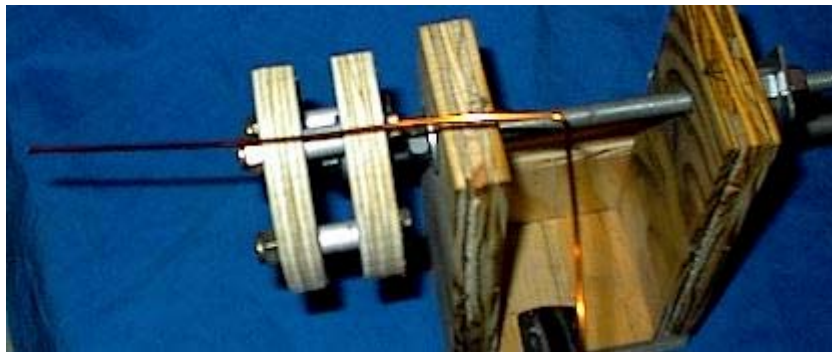

Feed the wire through the bottom of the "T" and the wire should be sticking out the front then give it a turn around the nut as below...

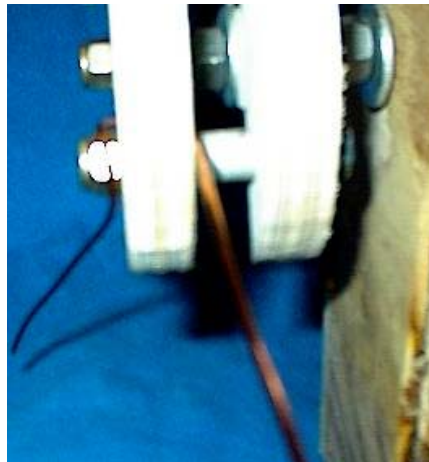

Then simply start turning slowly while holding a good amount of tension on the wire. The first layer should come out to 7 turns . Just continue the same way while counting the turns slowly until all 40-44 turns are completed. Below shows the first 7 turns on the winder...

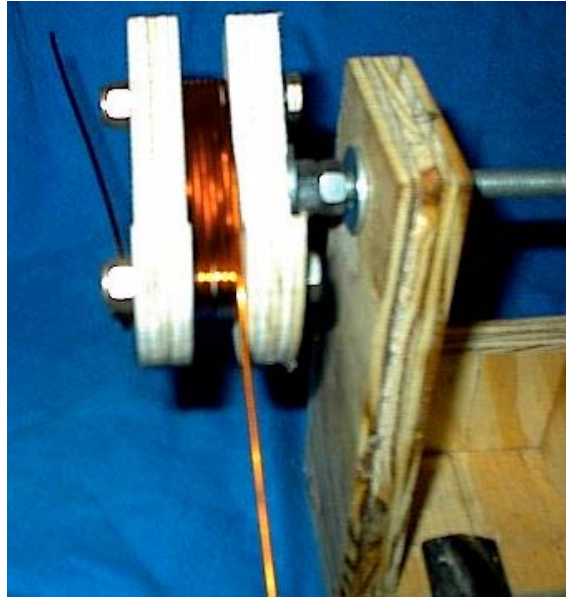

**When the coil is completed use some tape to go around the coil legs and hold them in place. Cut the tail of the end wire about the same length as the start wire. Once its taped on both legs and the wire is cut you can remove the front former and remove the coil. Shown below is the coil completed and ready to remove...**



**The next picture shows the coil still in place with the former removed and ready to come out...**



**Well, if the first one came out ok, you only have 8 more to go! Once all the coils are made we will wire them up and get them in place and ready to finish the stator...**

**Once the coils are done you can lay them out in the stator mold to make sure their going to fit. As shown below...**

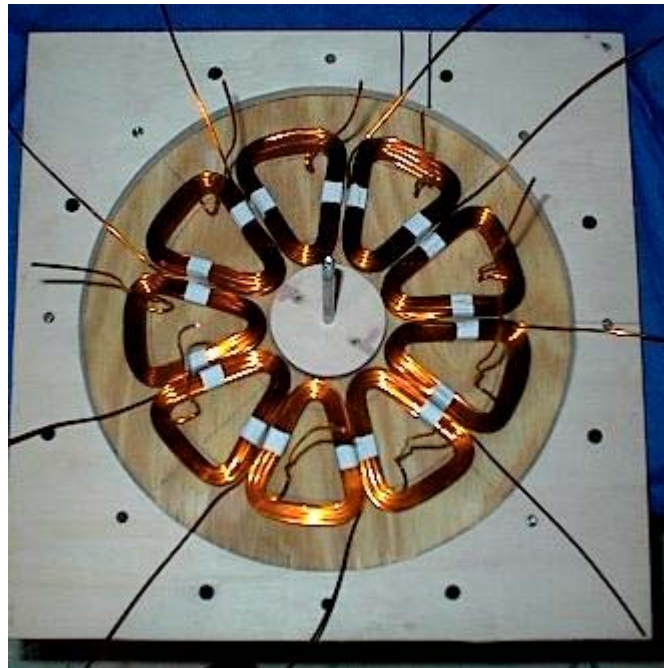

If you can't get all 9 coils in place then they probably have a bit of a "bow" to them. The design doesn't leave much extra space to work with so you may need to remove the bow. Below shows a completed coil, the yellow shows where the bow may occur while winding... This will happen on both sides of the coil not just one.



If they don't fit properly in the stator mold then it may be necessary to "tweek" the bow to get them in place properly. Remove the former head from the winding machine and reinsert the coil and put the former together with all the nuts snugged in place. As shown below.

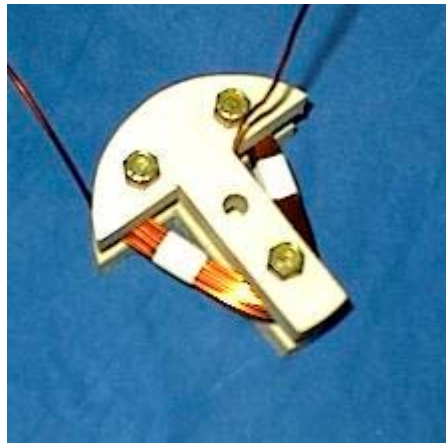

Take a rubber hammer ( preferably ) and tap it just hard enough to bend the stack of wires making them more of a straight line instead of being bowed. Do both sides this way. Be careful not to hit it so hard as to reverse the bow.

Below shows approximately where to tap the wires to remove the bow...



After all the coils have been tweaked, refit them in the mold to make sure you have a good fit. If all fit within the drawn magnet lines then its time to move on.

I've never found the "perfect" way to hold these coils in place while wiring them up so you're in a constant state of adjustment as you go. I start by putting tape over the tape that's on the coils joining the coils next to each other. Like I said not perfect but workable. Once all the coils are taped together we can begin wiring them up.

Below shows the coils taped in place. Also note the coils are taped to the center also as shown below by the yellow arrows...



Below is a diagram of how the coils are wired. This is a star configuration...

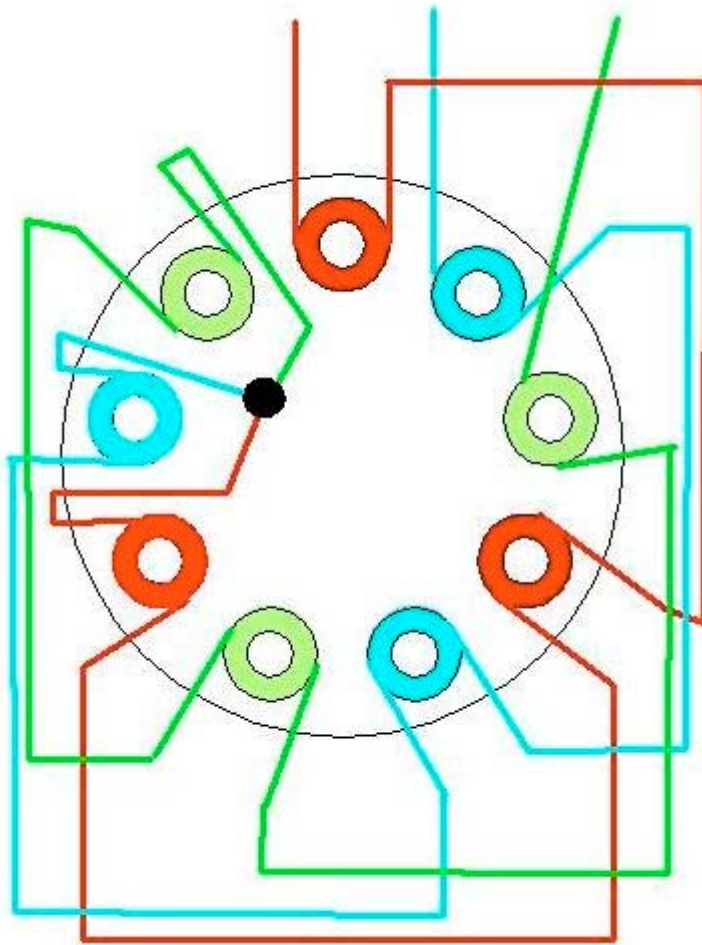

It can be somewhat overwhelming looking at all the wires sticking out if you've never done this. If you haven't then color coding the phases might be helpful to keep things going smoothly. You can choose whatever colors you have either markers, crayons whatever and mark them as in the diagram above. I usually solder up one phase at a time and double check every thing when each phase is completed. Including making sure there is a good connection with a meter when all is soldered.

You'll need to bend and tweek the wires around to get them in place. I usually use the halfway point between the coils to connect them. This way there is plenty of wire and space to work on them. Once you have a pair where you want them take a propane torch and burn off the coating where the two meet as shown below...





Once the coating is burned it makes it fairly easy to take some sandpaper and clean the copper. You want this as clean and shiny as possible to make sure the solder will stick. If there is any of the coating still on the wire the solder will not hold or make a proper connection. The wire is heavy enough you can hold one end while sanding the burnt area without disrupting the coils to badly...



Once the wire is clean and ready to solder take the two wires and twist them together tightly...

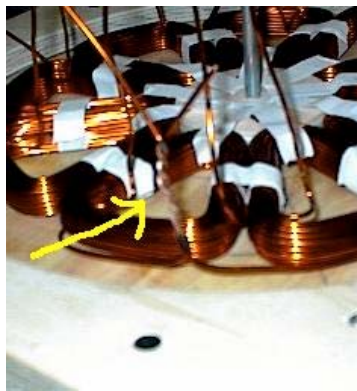

Once their twisted in place solder them up and continue through the first phase. When you've completed the first phase and tested it for continuity the 2<sup>nd</sup> and 3<sup>rd</sup> phases are the same as the first.

When all three phases are complete you'll have 3 start wires and 3 end wires. The three end wires will be cleaned, twisted and soldered together as in the wire diagram above. When all the soldering is completed you'll want to go around the stator and tuck the wires and soldered ends as close to the coils as possible leaving the outer edge clear of wires. You'll be drilling through the outer edge to bolt it to the stator plate later and you don't want to drill through any wires leaving the stator useless.

You'll need to remove the coils from the mold temporarily to prepare it for pouring the resin. I grabbed a board that was handy and laid it over the coils in the mold and turned the mold over allowing the coils to lay on the board. Once the coils are out the mold needs to be waxed so the resin won't stick to any of the surfaces. I used regular car wax on this one, I've used grease as well with good success but its messy.

Once its all waxed up real good, all exposed surfaces you'll need to cut 2 circles of fiberglass cloth that fit in the mold and over the center. One will go in before the coils and the other will be placed on top after its poured.... Below shows the mold waxed, fiberglass cloth in place and the coils reinstalled.

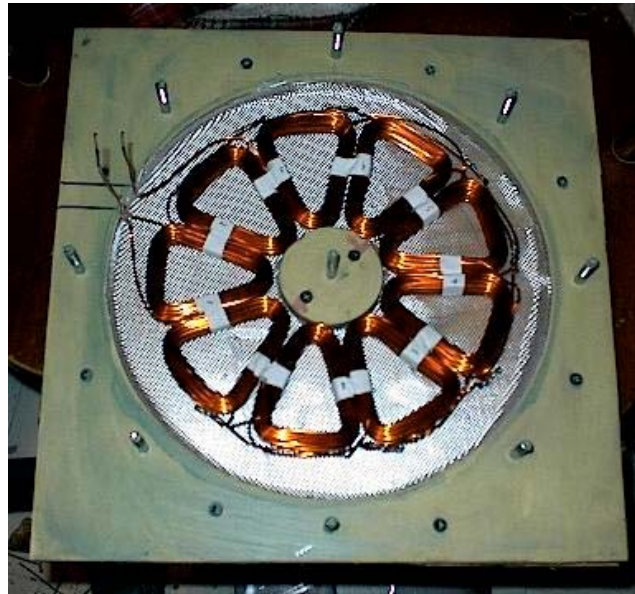

You may have to tweak the coils once again to make sure everything is lined up and in place. Make sure the 3 output wires are lined up with the slot for the cover which should have been marked earlier on the center mold. When your satisfied that everything is in place then place the mold on a level table or worktop with the lid slot pointed in a direction where the spill won't be a problem. Either let the spill go into a box, bucket, can whatever you can find so you don't make a mess.

Mix up about  $\frac{3}{4}$  of a quart in a plastic container of fiberglass resin following the mixing instructions carefully. Once it's poured it's a done deal whether it comes out nice or not. So, take your time and mix it well. Below shows the coils in place and resin poured in...

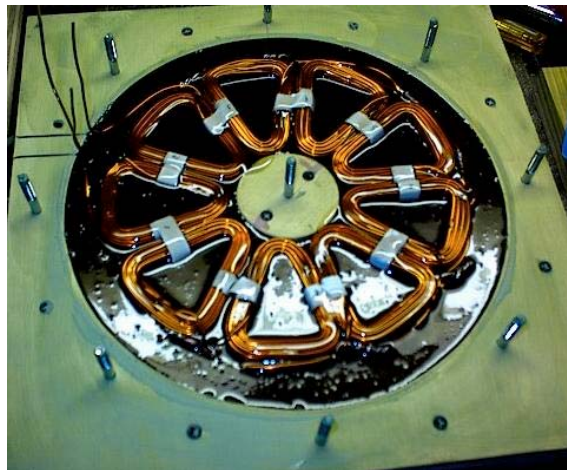

Once its poured take the second cloth circle and lay it over the top of the coils and get ready to put the lid on finishing the stator

Below shows the poured stator with the top cloth in place...

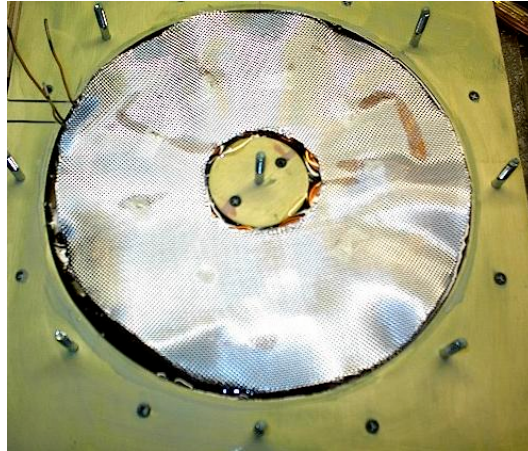

Below shows the lid in place and all the bolts tightened...



Now let it set for at least 24 hours for a good full cure before opening it up. The waiting is the hardest part...

Once the stator is cured, and all went well you can remove the cover. You may need to use a screwdriver to pry the lid off, if you put a good layer of wax on it, it should come off fairly easily. Once the lid is off remove the lid bolts, if you haven't already, and **unscrew** the center and outer portion of the mold itself. You may have to pry this a little to get it to loosen up. Once it off the bottom board you can tap around the edges to remove the mold board then knock out the center. If all went well you should be able to use the mold again and your stator is ready for drilling.

**NOTE: Be sure to position the output wires in an easy accessible place. You'll be mounting a box to wire the main pendant cable to the output wires later. Usually the side or the top is good but not the side of the yaw tube.**

**Drilling the holes for mounting: Place the stator over the face of the stator plate and center it. Use a couple clamps to hold it in place and simply drill the 4 - 5/16" holes. If the yaw tube is in the way of two holes simply remove the stator and turn it around. Use a couple 5/16" bolts in the holes you already drilled for alignment and re-clamp it.**

You can now assemble your alternator...

Start by getting the main shaft with the magnet disc spacer you positioned earlier. Make sure the set screw is nice and tight at this point because soon it will be impossible to reach. Also, this would be a good time to double check the bearings to make sure they are fully seated in the hub... last chance!

Slide one magnet disc on the back side of the shaft, If you forgot which end is which you can slide the shaft into the bearing hub to make sure. Install the  $\frac{1}{4}$ " aluminum spacer and drop the 4 -  $\frac{1}{4}$ " bolts in place. Note the bolts have one edge ground down for clearance around the spacer, this also serves to hold them in place when your tightening the front lock nuts without having to sneak a wrench in the back. See below... the arrows show the aluminum spacer in place and the flats on the bolts...

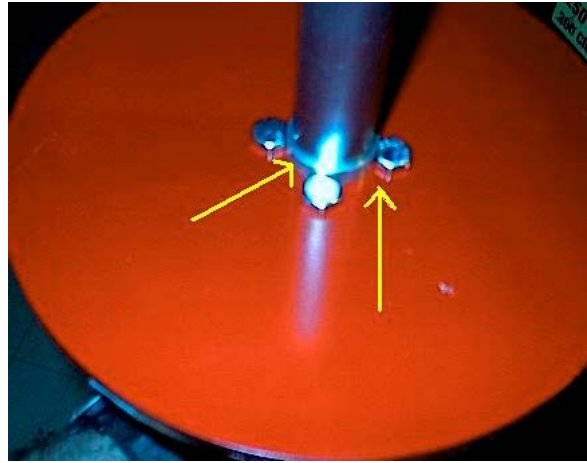

Slide the disc, shaft and assembly in the bearing hub and install the locking collar on the back of the shaft and tighten it in place. Your assembly should look something like the below picture...



Remember the X placed on the “top” magnet? You’ll want to mark the bolt on the spacer with a marker so you’ll know which magnet lines up on the second disc. Once the stator is installed you won’t be able to see the magnet with the X. Install the 4 - 5/16” threaded rods into the stator mounting holes and tighten them. Install the stator nuts and 1 washer on each for the back side of the stator. Run the nuts all the way down to the mounting nuts so the stator lays against the magnet disc. The top nuts and washers will be installed after the second disc is in place.

Slide the stator onto the unit lining up the bolt holes you drilled noting the position of the output wires as well as the direction. You want the wires pointing toward the stator mounting plate. If it goes on hard you can open the holes up a little bit for an easier fit, **don’t force it as it could crack the plastic and you’ll have to start over.** Once the stator is on and against the first magnet disc you can install the second disc. The assembly should look like the below picture... Note the mark on the aluminum spacer for locating the second disc.

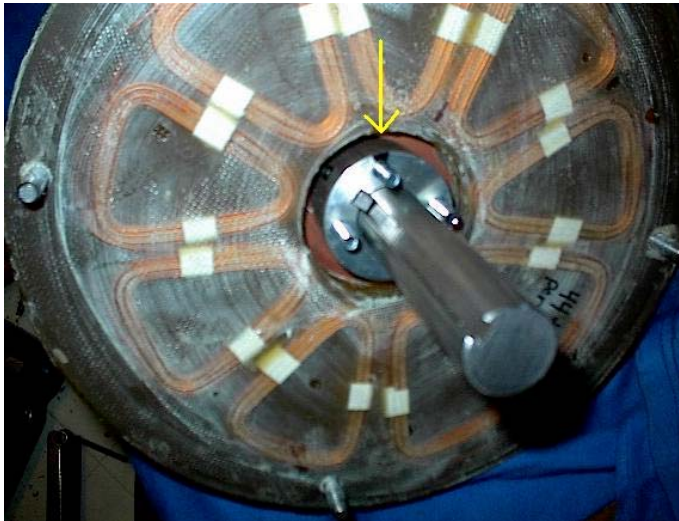

**When installing the second disc, Place 1 piece of 3/4” plywood scrap on each side of the stator. DO NOT try to install the disc with out them in place! It could be painful!**

Find the “X” on the second disc and mark the bolt hole on the back side of the disc so you know which one lines up with the rear disc. Slide the disc down onto the plywood pieces. Once its down line up the mark with the proper bolt hole. Remove one piece of plywood from one side and the disc will drop on that side. Use a smaller piece of 1/2” scrap to place under the side you just removed the 3/4” piece from. Slowly remove the other piece of 3/4” plywood until the disc drops into place over the bolts. Then remove the 1/2” piece and it should drop into place. Install the 4 nyloc nuts. They don’t have to be torqued just snug. When completed the assembly should look like below...



**Note the direction of the wires, pointed toward the back of the machine. Now you can install the nuts and washers for the stator and adjust the stator so it rides in the center of the magnet gap. You want the gap on both sides to be close to the same. You should use a loctite blue on the stator nuts so they don't vibrate loose while in operation. These nuts should be tight but not torqued excessively or you could break the plastic.**

## Tail and Furling system

Find the parts for the tail section as shown below...



Begin by welding the top bracket to the pivot tube, then the boom tube to the side of the pivot tube so the top of the tube touches the boom mounting tube. The boom mounting tube has a special 20 degree cut that is shaped to fit the pivot tube. Make sure the two tubes fit together tightly and weld everything in place. When you're done it should look similar to the below picture...



To make the tail boom you'll need a  $\frac{3}{4}$ " schedule 40 pipe about 3 feet long. Preferably non-galvanized because you'll be doing some welding to the end and to mount it. If your kit was ordered as a welded kit then it doesn't matter because it will be bolted together.

Next weld the angle bracket on the end of the  $\frac{3}{4}$  inch tube as shown below...



It's a good idea at this point to find a place that the turbine head assembly can be mounted over a 1 inch schedule 40 tube. We'll be working on getting the "notch" cut in the pivot tube that will determine where the stops are located. This will allow the tail to swing only in a given area.

When the turbine head is mounted slide the tail boom into the boom tube mount on the tail pivot and install the assembly onto the angle bracket on the turbine head. Align the tail so its slightly off from center and mark the tube where the bracket is welded as the picture below...



Mark it just behind the weld, the weld will become the stop so the tail doesn't swing out any farther. Don't mark it at 90 degrees from the head, let it swing out a few degrees farther but not more than 110 degrees. Once you have this mark on the tube swing the tail into its furled position and mark



**the tube on the other side. You want this mark so it holds the tail away from the blades and even a bit farther so its not completely parallel with the turbine stator plate. As shown below...**



**Once it's marked on both sides you need to find the depth of the cut. Measure down from the top of the tail pivot tube to the top of the angle bracket then transfer the measurement to the pivot tube.**

**You want to cut it just slightly higher than that so the slot doesn't ride on the bracket. The pivot should ride on the bracket inside the tube.**

**After the tube is marked for the slot and depth cut that section out... below shows the tube marked for the cut.**



Mark the bottom of the tube so you can see where the cut will start as in the picture below...



You can use a hack saw to cut the slot down to the depth mark then cut the depth mark down to the cuts in the tube. When the slot is cut out it should look similar to the picture below...



Slide the boom into the boom tube and install it on the turbine head. Check that the normal stop and furled stop positions are where you want them. If you need it to go a little farther you can cut a little extra from either side to finish tweeking it. If it swings to far then you'll need to weld in a piece to make a new stop.

**Note: If you ordered a welded kit this piece is already notched and simply has to be assembled.**

Now if everything is fine then we can make a tail feather for the turbine. I used a piece of  $\frac{3}{4}$ " plywood that was left over from cutting the mold parts, which turned out to be 14" tall by 20" long. You need a minimum of 1  $\frac{1}{2}$  square foot, any size larger than that will work fine. Also, it can be of any shape you want although I'm kind of stuck with simple basic.

After the tail feather is cut out lay it on the floor and place the tail boom on top. The tail needs to be at least 3  $\frac{1}{2}$  foot long minimum. So the tail feather will make up the difference hanging over. Center

it up and drill 3 holes  $\frac{1}{4}$  inch. 2 holes in the angle bracket and 1 through the tube. You'll need 2 – 1  $\frac{1}{4}$  inch long  $\frac{1}{4}$  inch bolts and one 2 inch long  $\frac{1}{4}$  inch bolt with nuts washers and lock washers.  
Shown below is the tail drilled and bolted to the boom...



When you're done bolting it up you can align it on the wind turbine head. Slide the boom and tail in the boom mounting tube and make sure the tail is straight up and down. Once its aligned you can drill it for 2 –  $\frac{1}{4}$  inch bolts through all the tubes or weld it in place.

The next step will determine at what wind speed the turbine will furl. You may need to add some weight to the tail. Tap a nail in the end of the tail feather and use a fish scale to measure the tail tip weight. The pivot end of the tail should be setting on the ground and the tail suspended by the scale. You should have about 10 to 12 lbs of weight to get it to start furling in a 25 to 28 mph wind. The weight can be a simple block of steel. Drill 2 holes in it and through the tail board and bolt it on.

Once everything is finalized you can paint the parts and set them aside.

**Note:** To lock the tail on the machine You can drill the center of the tail pivot bracket and make a washer or flat bar with a hole drilled for the bottom then drop a piece of  $\frac{1}{4}$  inch threaded rod through the center. Use nyloc nuts on both ends but don't tighten it, simply let it hang free with plenty of clearance to allow it to move through the furling cycle without any obstructions. This will assure that the tail will remain on the machine. I don't believe it's actually needed but as a precaution it couldn't hurt

Only thing left to do is make some blades for the prop and mount them on the machine. This will be a separate section.